

Track Accessories

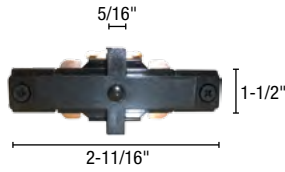

**MINI-CONNECTOR
CONDUCTIVE**

- ST22-BK
- ST22-WH
- ST22-SI

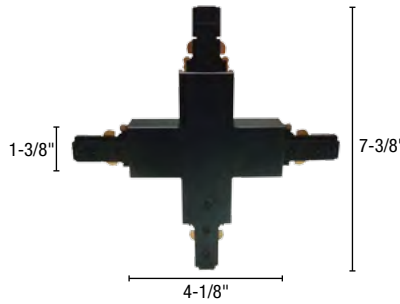

X-CONNECTOR

- ST25-BK
- ST25-WH
- ST25-SI



**END FEED
(TOP ACCESS)**

- ST38-BK
- ST38-WH
- ST38-SI

**REVERSE
POLARITY**

- ST38A-BK
- ST38A-WH
- ST38A-SI



**FLEXIBLE CONNECTOR
35° to 325° SINGLE CIRCUIT**

- ST28-BK
- ST28-WH
- ST28-SI

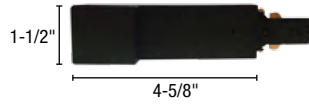

**SURFACE
CONDUIT
END FEED**

- ST27-BK
- ST27-WH
- ST27-SI

**REVERSE
POLARITY**

- ST27A-BK
- ST27A-WH
- ST27A-SI



FLOATING FEED

- ST26-BK
- ST26-WH
- ST26-SI

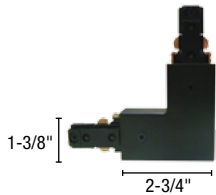

THREE WAY «L» JOINER

- ST23-BK
- ST23-WH
- ST23-SI

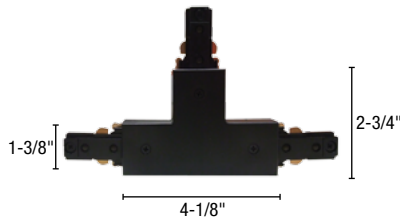

T-CONNECTOR

- ST24-BK
- ST24-WH
- ST24-SI

REVERSE POLARITY

- ST24B-BK
- ST24B-WH
- ST24B-SI



MONOPOINT

- ST40-BK
- ST40-WH
- ST40-SI

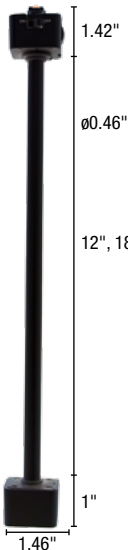

LINE VOLTAGE EXTENSION

- JLVE-12-WH
- JLVE-18-BK
- JLVE-18-WH
- JLVE-24-BK
- JLVE-24-WH
- JLVE-36-BK



GROUNDING OUTLET

- ST33-BK
 - ST33-WH
 - ST33-SI
- Not UL listed**

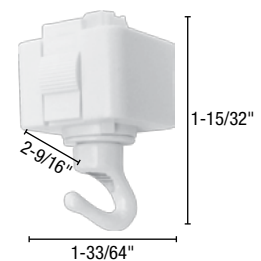

UTILITY HOOK

- ST34-BK
 - ST34-WH
 - ST34-SI
- (10 lbs capacity)
Not UL listed